





1-800-BOLLARDS

The Bollard Experts

- SELECT DESIRED MATERIAL:
(6" NOMINAL SIZE)
 - FCSC06040 SCH 40 STAINLESS STEEL
 - FCSC06040 SCH 40 ASTM A-53 CARBON STEEL
- SELECT DESIRED STAINLESS STEEL BOLLARD FINISH:
 - POLISHED #4 FINISH
 - AS SPECIFIED _____
- SELECT DESIRED CARBON STEEL BOLLARD FINISH:
 - POWDER COAT RAL # _____
 - AS SPECIFIED _____
- SELECT DESIRED STAINLESS STEEL BOLLARD MATERIAL:
 - TYPE 304
 - TYPE 316
- SELECT DESIRED BOLLARD CAP STYLE:
 -  DOME
 -  STANDARD FLAT
 -  REVEAL
 -  SLOPED

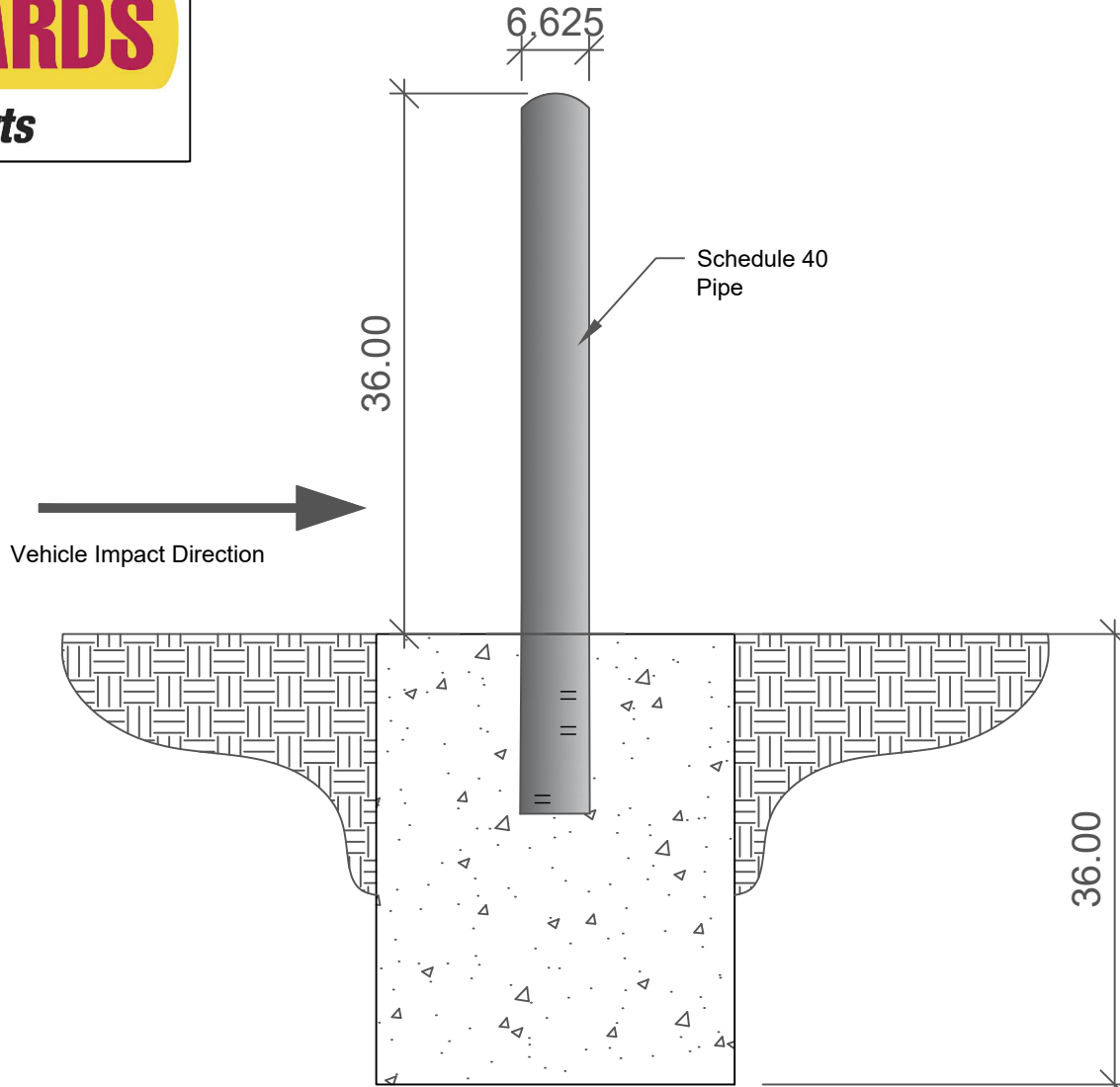

REVISIONS			
LTR	DESCRIPTION	DATE	APPVD
COMMENTS			
SPECIFICATIONS			
HEIGHT: 36"			
DIAMETER: 6.625"			
WALL THICKNESS: 0.280"			

DOME
 STANDARD FLAT
 REVEAL
 SLOPED

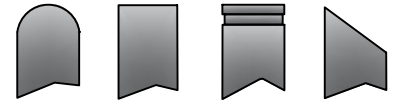

END VIEW-FOUNDATION





NOTES:
 1. INSTALLATION TO BE COMPLETED IN ACCORDANCE WITH MANUFACTURER'S SPECIFICATIONS.
 2. DO NOT SCALE DRAWING.
 3. THIS DRAWING IS INTENDED FOR USE BY ARCHITECTS, ENGINEERS, CONTRACTORS, CONSULTANTS AND DESIGN PROFESSIONALS FOR PLANNING AND INSTALLATION PURPOSES.
 4. ALL INFORMATION CONTAINED HEREIN WAS CURRENT AT THE TIME OF DEVELOPMENT BUT MUST BE REVIEWED AND APPROVED BY THE PRODUCT MANUFACTURER TO BE CONSIDERED ACCURATE.

APPLICATION	
NEXT ASSY	USED ON

SERIES NUMBER: XX-S060-XX	CAGE CODE: 6NGJB	REV: 6" CT FIXED
PRODUCT FAMILY: 20 MPH CRASH TESTED	DRAWN BY: AJA	DRAWING REV: 1
PRODUCT CLASS: STANDARD OR CUSTOMER DEFINED	CHECKED BY:	SHEET: 1 OF 1
PRODUCT LINE: BOLLARD	APPROVED BY:	RELEASE DATE:
PRODUCT SUB LINE: FIXED	1-800-BOLLARDS, Inc. 10 Hughes Suite A105 Irvine, CA 92618 PHONE: 1-800-BOLLARDS WEB: WWW.1800BOLLARDS.COM EMAIL: INFO@1800BOLLARDS.COM	
BOLLARD, CT FIXED		

1-800-BOLLARDS

The Bollard Experts

- SELECT DESIRED MATERIAL:
(6" NOMINAL SIZE)
 - FCSC06040 SCH 40 STAINLESS STEEL
 - FCSC06040 SCH 40 ASTM A-53 CARBON STEEL
- SELECT DESIRED STAINLESS STEEL BOLLARD FINISH:
 - POLISHED #4 FINISH
 - AS SPECIFIED _____
- SELECT DESIRED CARBON STEEL BOLLARD FINISH:
 - POWDER COAT RAL # _____
 - AS SPECIFIED _____
- SELECT DESIRED STAINLESS STEEL BOLLARD MATERIAL:
 - TYPE 304
 - TYPE 316
- SELECT DESIRED BOLLARD CAP STYLE:
 -  DOME
 -  STANDARD FLAT
 -  REVEAL
 -  SLOPED

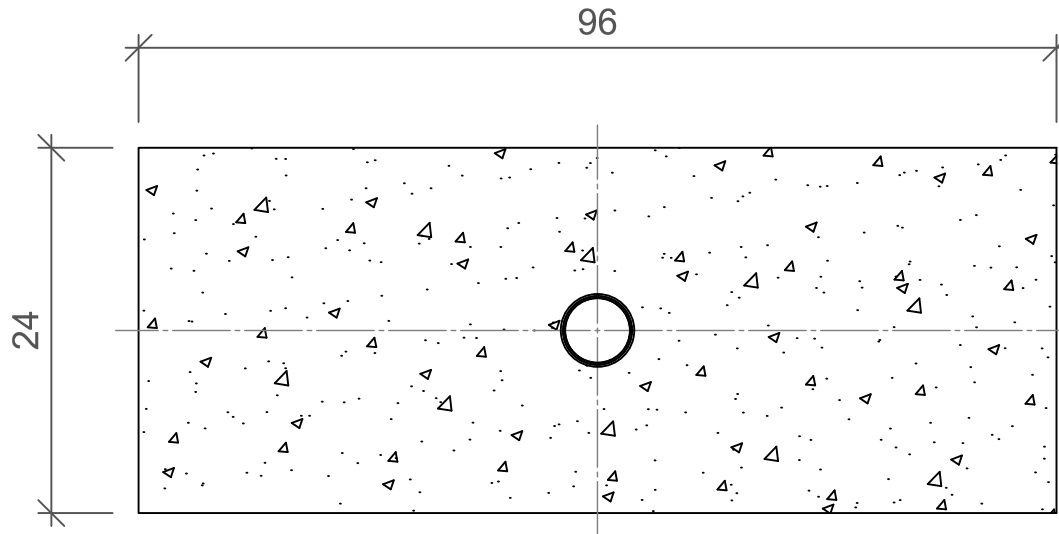

REVISIONS			
LTR	DESCRIPTION	DATE	APP

SPECIFICATIONS

HEIGHT: 36"
 DIAMETER: 6.625"
 WALL THICKNESS: 0.280"

PLAN VIEW-FOUNDATION

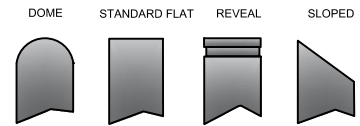

NOTES:
 1. INSTALLATION TO BE COMPLETED IN ACCORDANCE WITH MANUFACTURER'S SPECIFICATIONS.
 2. DO NOT SCALE DRAWING.
 3. THIS DRAWING IS INTENDED FOR USE BY ARCHITECTS, ENGINEERS, CONTRACTORS, CONSULTANTS AND DESIGN PROFESSIONALS FOR PLANNING AND INSTALLATION PURPOSES.
 4. ALL INFORMATION CONTAINED HEREIN WAS CURRENT AT THE TIME OF DEVELOPMENT BUT MUST BE REVIEWED AND APPROVED BY THE PRODUCT MANUFACTURER TO BE CONSIDERED ACCURATE.

APPLICATION		SERIES NUMBER		CASE CODE		REV		DRAWING NUMBER	
NEXT ASBY	USED ON	1-800-BOLLARDS, Inc.	XX-S060-XX	6N0J8	8'	CT	FIXED	8'	CT
		10 Hughes Suite 1100	20 MPH CRASH TESTED						
		Irwin, CA 93658	STANDARD OR CUSTOMER DEFINED	AJA					
		PHONE/ 1-800-BOLLARDS	BOLLARD						
		WEBSITE: WWW.1800BOLLARDS.COM	FIXED						
		EMAIL: INFO@1800BOLLARDS.COM							
		TITLE:		BOLLARD, CT FIXED					
				APPROVED BY:		RELEASE DATE:			

1-800-BOLLARDS

The Bollard Experts

REVISIONS			
LTR	DESCRIPTION	DATE	APPVD
COMMENTS			
SPECIFICATIONS			
HEIGHT: 36"			
DIAMETER: 6.625"			
WALL THICKNESS: 0.280"			

- SELECT DESIRED MATERIAL:
(6" NOMINAL SIZE)
 - FCSCT06040 SCH 40 STAINLESS STEEL
 - FCSCT06040 SCH 40 ASTM A-53 CARBON STEEL
- SELECT DESIRED STAINLESS STEEL BOLLARD FINISH:
 - POLISHED #4 FINISH
 - AS SPECIFIED _____
- SELECT DESIRED CARBON STEEL BOLLARD FINISH:
 - POWDER COAT RAL # _____
 - AS SPECIFIED _____
- SELECT DESIRED STAINLESS STEEL BOLLARD MATERIAL:
 - TYPE 304
 - TYPE 316
- SELECT DESIRED BOLLARD CAP STYLE:
 - DOME
 - STANDARD FLAT
 - REVEAL
 - SLOPED

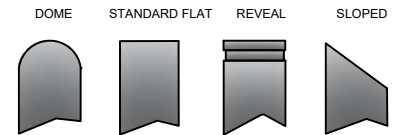
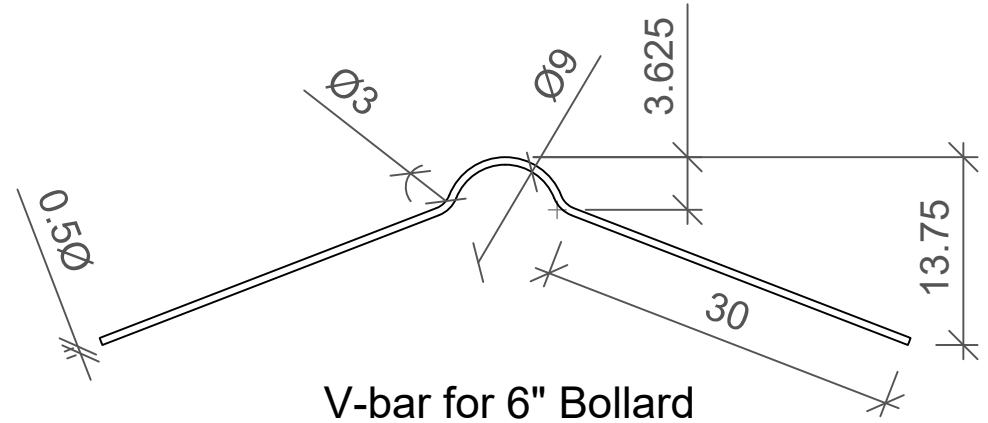
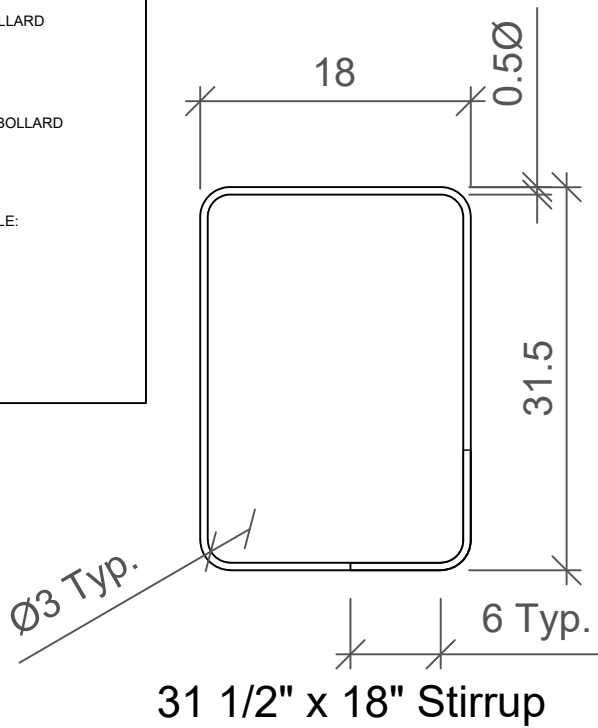

NOTES:
 1. INSTALLATION TO BE COMPLETED IN ACCORDANCE WITH MANUFACTURER'S SPECIFICATIONS.
 2. DO NOT SCALE DRAWING.
 3. THIS DRAWING IS INTENDED FOR USE BY ARCHITECTS, ENGINEERS, CONTRACTORS, CONSULTANTS AND DESIGN PROFESSIONALS FOR PLANNING AND INSTALLATION PURPOSES.
 4. ALL INFORMATION CONTAINED HEREIN WAS CURRENT AT THE TIME OF DEVELOPMENT BUT MUST BE REVIEWED AND APPROVED BY THE PRODUCT MANUFACTURER TO BE CONSIDERED ACCURATE.

APPLICATION	NEXT ASSY	USED ON	SERIES NUMBER: XX-S060-XX PRODUCT FAMILY: 20 MPH CRASH TESTED PRODUCT CLASS: STANDARD OR CUSTOMER DEFINED PRODUCT LINE: BOLLARD PRODUCT SUB LHM: FIXED 1-800-BOLLARDS, Inc. 10 Hughes Sutte Altds Irvine, CA 92618 PHONE: 1-800-BOLLARDS WEB: WWW.1800BOLLARDS.COM EMAIL: INFO@1800BOLLARDS.COM	CASE CODE: 6NGJ8 SIZE: 6" CT FIXED DRAWN BY: AJA CHECKED BY: _____ APPROVED BY: _____	DRAWING NUMBER: SHEET 1 OF 1 TITLE: BOLLARD, CT FIXED